

ISTITUTO NAZIONALE DI FISICA NUCLEARE
Laboratori Nazionali di Frascati

LNF-86/57

G. Battistoni, P. Campana, V. Chiarella, U. Denni, E. Iarocci, G. Mazzenga,
and F. Ronga:
MUON TRACKING UNDERGROUND

Estratto da:
Nuovo Cimento 9C, 653 (1986)

Servizio Documentazione
dei Laboratori Nazionali di Frascati
Cas. Postale 13 - Frascati (Roma)

Muon Tracking Underground.

G. BATTISTONI, P. CAMPANA, V. CHIARELLA, U. DENNI
E. IAROCCI, G. MAZZENGA and F. RONGA

Istituto Nazionale di Fisica Nucleare - Laboratori Nazionali di Frascati, Italia

(ricevuto il 12 Agosto 1985)

Summary. — We present a new design of plastic streamer tubes, optimized to match the experimental requirements of large-area underground detectors, where muon identification is needed with good angular resolution.

PACS. 90.40 - Cosmic rays.

1. - Introduction.

Underground muon tracking detectors of the next generation must cover large areas, need a large number of sensitive elements, and must be operated for several years of effective running time.

Plastic streamer tubes are well suited for this application, in particular for their high reliability and low cost.

In the framework of the design study for the MACRO experiment at the Gran Sasso ⁽¹⁾, we have developed a new version of plastic streamer tubes, in order to cover the needs of a large-area apparatus ($\geq 1000 \text{ m}^2$), where muon tracking with good angular resolution is an essential detection feature, for instance in view of the search for high-energy point sources of cosmic rays.

So far, plastic streamer tubes have been mostly used in digital tracking

⁽¹⁾ MACRO proposal Frascati (1984), unpublished.

calorimeters (NUSEX ⁽²⁾, LEP hadron calorimeters ⁽³⁾, etc.) where events with a high density of tracks are produced. For this reason a granularity of $\sim 1 \text{ cm}^2$ ($\Delta x, \Delta y \sim 3 \text{ mm}$) is used.

In the case of muon tracking it is convenient to use a larger active cell ($\sim (3 \times 3) \text{ cm}$)²; the resulting two-track separation is good also for multimMuon events.

With digital strip read-out, the achievable space accuracy is $\sim 1 \text{ cm}$ in the two views, which allows an angular resolution of a few tenths of a degree, provided that the apparatus has a lever arm exceeding 2 m. Such a resolution is in general better than the physical limit due to the muon deflection caused by geomagnetic field and multiple scattering in the rock ⁽⁴⁾.

A space accuracy of the order of $\Delta x, \Delta y \sim 1 \text{ mm}$ can be obtained by drift time readout in one view, as in conventional drift tubes, and the charge centroid method on the other co-ordinate ⁽⁵⁾. Often a single drift time readout channel can be used for a few wires in OR, due to the low track density.

Plastic streamer tubes can be assembled in modules longer than 10 m, so that apparatus with several layers with surface areas over 1000 m² can be easily designed.

Streamer tubes have other noticeable features, such as a low ionization threshold, at the level of a single ion pair, and are able to identify specific ionization losses $\Delta E/\Delta X \gg \Delta E/\Delta X_{\text{min ion}}$.

2. - The streamer tube module.

The mechanical structure of the new plastic streamer tubes is basically the same as that used in the Mont Blanc detector ⁽⁶⁾. As shown schematically in fig. 1, the tube system has a modular structure consisting of units containing 8 individual tubes (8-tube units). They are equipped with pick-up

⁽²⁾ G. BATTISTONI, E. BELLOTTI, C. BLOISE, G. BOLOGNA, P. CAMPANA, C. CASTAGNOLI, V. CHIARELLA, D. C. CUNDY, B. D'ETTORRE PIAZZOLI, E. FIORINI, E. IAROCCI, G. MANNOCCHI, G. P. MURTAS, P. NEGRI, G. NICOLETTI, P. PICCHI, M. PRICE, A. PULLIA, S. RAGAZZI, M. ROLLIER, F. RONGA, O. SAAVEDRA and L. ZANOTTI: *The NUSEX experiment*, to be submitted to *Nucl. Instrum. Methods*.

⁽³⁾ See, for instance, ALEPH int. tech. rep. 1 (Geneva, 1983).

⁽⁴⁾ G. BOLOGNA, C. CASTAGNOLI, A. CASTELLINA, A. CIOCIO, B. D'ETTORRE PIAZZOLI, P. GALEOTTI, G. MANNOCCHI, P. PICCHI, O. SAAVEDRA, S. VERNETTO, E. BELLOTTI, E. FIORINI, C. LIGUORI, P. NEGRI, A. PULLIA, S. RAGAZZI, M. ROLLIER, L. ZANOTTI, G. BATTISTONI, C. BLOISE, P. CAMPANA, V. CHIARELLA, E. IAROCCI, G. P. MURTAS, G. NICOLETTI, L. SATTI, D. C. CUNDY and M. PRICE: *Nuovo Cimento C*, **8**, 76 (1985).

⁽⁵⁾ A. BETTINI, G. Busetto, R. CONTE, M. DE GIORGI, D. PASCOLI and P. L. ZOTTO: UAI-PD83/1, Padova (1984).

⁽⁶⁾ G. BATTISTONI, U. DENNI, E. IAROCCI, G. MAZZENGA, G. NICOLETTI and L. TRASATTI: *Nucl. Instrum. Methods*, **176**, 297 (1980).

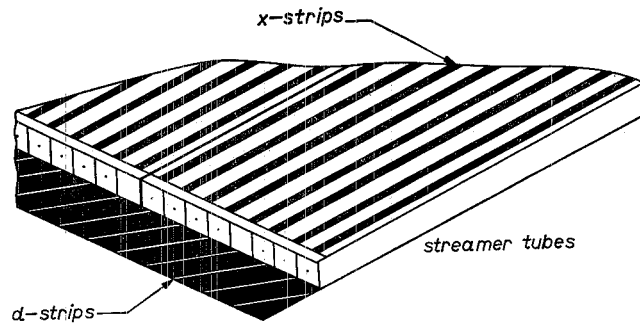

Fig. 1. - Schematic sketch for a plastic streamer tube layer for large-area detectors. Many 8-tube units can be combined together. Two-dimensional localization is performed by two sets of pick-up strips. They can be placed at any angle according to the experimental requirements.

strips for two-dimensional localization. Such strips can be put at any angle with respect to the wires, according to the experimental requirements.

The cross-section of the 8-tube is shown in fig. 2. The single cell is (3×3) cm², and the wire diameter is 60 μ m. This choice allows a better detection efficiency for very low ionization (⁷) (at the level of a single primary ion pair) and thus covers a specific need of the MACRO experiment.

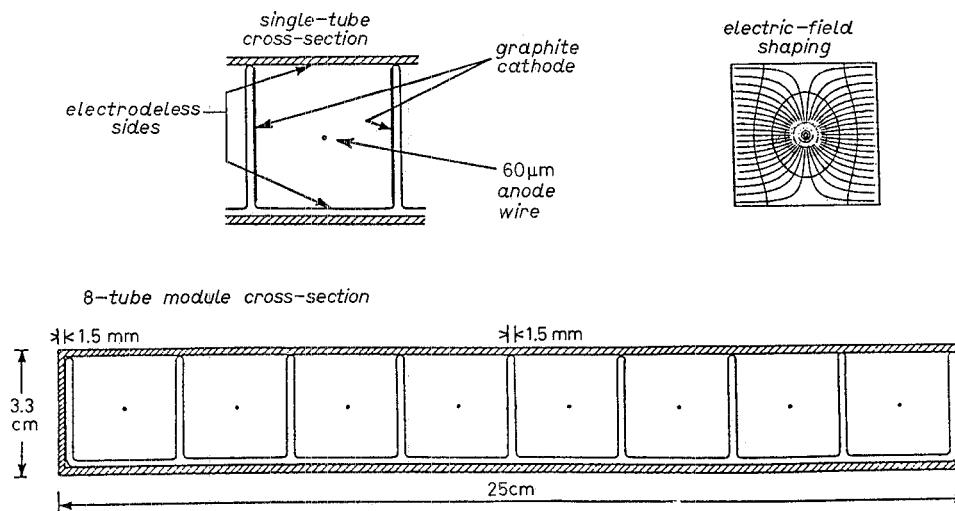

Fig. 2. - Cross-section of an 8-tube unit. The electric field shaping is given by the wire, the graphite cathode and the positive ion charge deposited in the electrodeless faces by stationary streamer operation.

(⁷) G. BATTISTONI, P. CAMPANA, U. DENNI, B. D'ETTORRE PIAZZOLI, E. IAROCCHI, M. MESCHINI and F. RONGA: *Nucl. Instrum. Methods A*, **235**, 91 (1985).

The electric field shaping is electrodeless⁽⁸⁾, *viz.* two sides of the cell are conductive (low-resistivity graphite) and two are insulating. Plastic inserts support the wire every 1 m, which avoids operation and handling problems for long modules. Limitations to the total module length come from practical problems such as transportation. For the MACRO experiment this fixes the maximum module length at 12 m.

The wires of each unit are soldered at both ends on printed circuit boards, where they are connected to a common high voltage. This connection and the ground connection to the graphite are on one of the two end caps which close the 8-tube unit. Gas distribution to the tubes is through connectors on both caps.

The large cell gives the possibility of using a wide set of gas mixtures; in particular, instead of the standard Ar + isobutane gas mixture, one can use He + *n*-pentane. Helium is of interest for slow monopole detection, because of the Drell-Penning effect⁽⁹⁾; *n*-pentane is advantageous for safety reasons, being a liquid at room temperature.

3. - Tube performance.

All the operation test have been performed on a tube module flowed with the He + *n*-pentane 3:1 gas mixture. The tube module is equipped with two sets of pick-up strips (3 cm pitch); one set is parallel to the wires (*x*-strips) and the other is at $\sim 30^\circ$ with respect to the wires (*d*-strips), according to the scheme of fig. 1. They are made of 40 μm thick aluminum strips on one side of a plastic sheet. Another sheet of aluminum is attached to the other side of the plastic sheet and serves as the ground electrode.

Figure 3 shows the singles counting rate as a function of HV for isotropic β -rays, together with the counting curve for single photoelectrons, which are completely equivalent to single ionization electrons⁽⁷⁾. A full efficiency plateau ~ 600 V wide is obtained, with no spurious pulse production. Streamer pulses at the operation voltage of 4400 V with a β source are shown in fig. 4 for both the wires and the strips. The big pulses allow the use of cheap readout electronic. No attenuation is practically measurable on very long strips (~ 15 m).

The *x*-strips readout is completely equivalent to the conventional wire readout. The space resolution with digital readout is ~ 1 cm, *i.e.* the equivalent r.m.s. of a flat distribution over 3 cm width. For the *d*-strips, by taking

⁽⁸⁾ G. BATTISTONI, P. CAMPANA, V. CHIARELLA, A. CIOCIO, U. DENNI, E. IAROCCHI, G. MANNOCCHI, M. MESCHINI, G. NICOLETTI and P. PICCHI: *Nucl. Instrum. Methods*, **217**, 429 (1983).

⁽⁹⁾ S. D. DRELL, N. M. KROLL, M. T. MUELLER, S. J. PARKER and M. A. RUDERMAN: *Phys. Rev. Lett.*, **50**, 644 (1983).

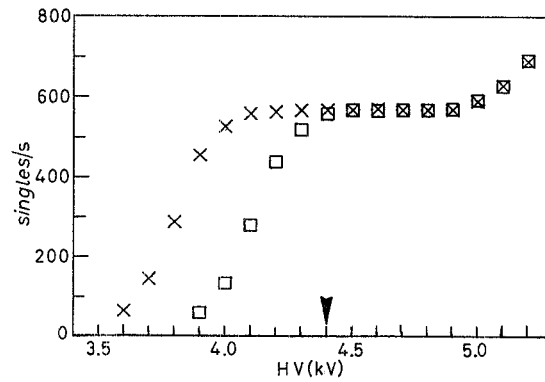

Fig. 3. - Singles counting rate for the streamer tubes for isotropic electrons (^{90}Sr) and single photoelectrons. Starting from ~ 4.4 kV, single electrons are detected with practically full efficiency and without spurious pulse detection. (3×3) cm 2 , 60 μm , He+n-pentane, 3:1. x β , \square single electron.

the geometrical centre of the pattern of the hit strips, it allows us to get the same ~ 1 cm resolution as the x -strips, in spite of the factor of two loss from the stereo angle. The good spatial accuracy comes simply from the fact that a track near the centre of a strip will fire mostly one strip, while a track near the junction of two strips will fire mostly two strips.

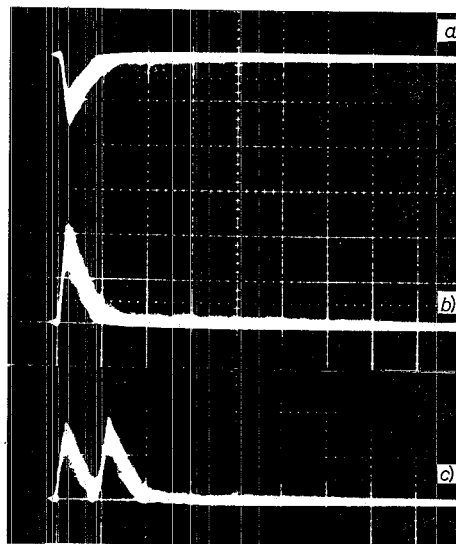

Fig. 4. - The horizontal scale is 100 ns/div. In the last case the reflection from the nonterminated end is visible. No attenuation is seen after ~ 30 m propagation, indicating no problems with these dimensions: a) wire pulses at 4.4 kV, 50 mV/div; b) induced pulses on a 1 m long x -strip, 20 mV/div, 100 Ω terminator; c) induced pulses on a 15 m long d -strip (30° with respect to the wires), 10 mV/div, 50 Ω terminator.

We have measured the drift time distribution for cosmic rays distributed between 0° and 40° with respect to the vertical. The result is shown in fig. 5; the measured time resolution is ~ 150 ns.

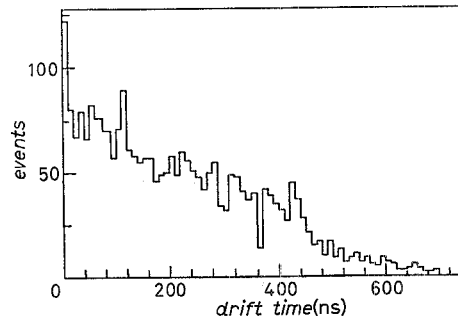

Fig. 5. — Drift time distribution for the streamer tubes as measured with cosmic rays. The distribution is that expected given the geometry of the cell. The resulting time accuracy is ~ 150 ns. (3×3) cm², $60 \mu\text{m}$; He+n-pentane, 3:1, HV = 4.4 kV.

Figure 6 shows the average streamer charge for minimum-ionizing particles as a function of the angle of incidence with respect to the wire direction. The number of streamers generated by a single track is a measure of the projected track length along the wire. The relevant parameter is the streamer dead region along the wire. This region is determined by the gas mixture.

Streamer tubes can also give information concerning the particle ionization loss. Figure 7 shows the pulse height distribution due to single electrons,

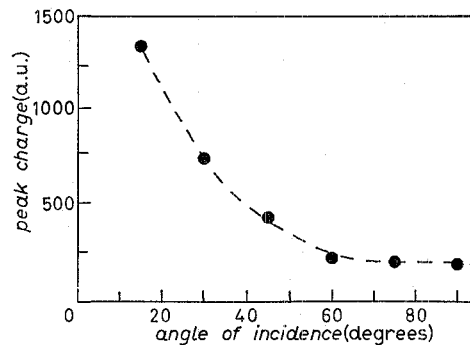

Fig. 6. — Streamer pulse height vs. the angle of the track with respect to the wire, as measured with cosmic rays. For a given streamer dead region length (fixed by the gas mixture) the pulse height is a measure of the track projection along the wire. (3×3) cm², $60 \mu\text{m}$, μ , He+n-pentane, 3:1, 4.4 kV.

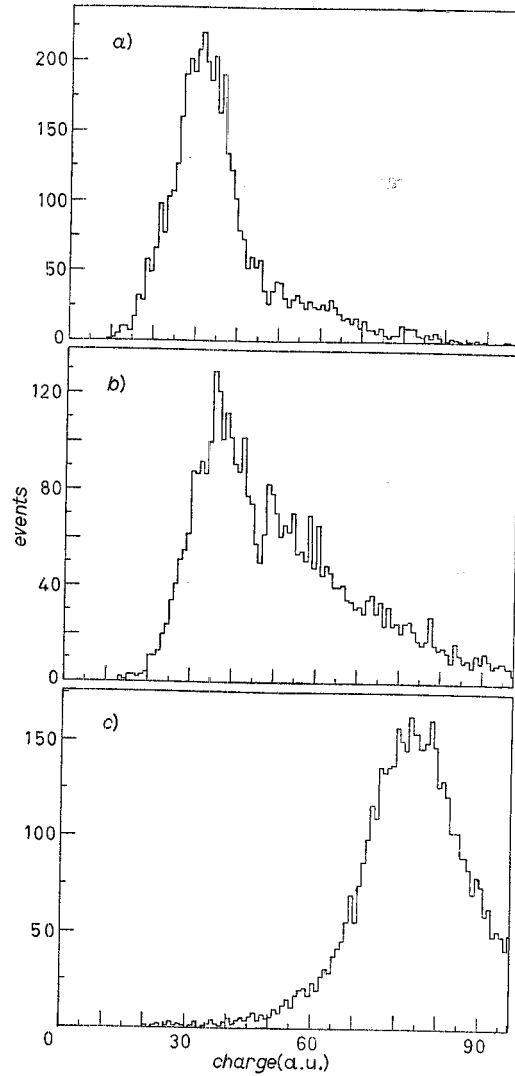

Fig. 7. - Streamer pulse height distribution with our tube module and gas mixture for a) single electrons, b) isotropic minimum-ionizing particles and c) isotropic heavily ionizing α -particles. This preliminary result shows the capability of streamer tubes to detect large ionization losses with respect to the minimum.

isotropic minimum-ionizing particles, and heavily ionizing α -particles from an ^{241}Am source (ionization loss ~ 200 times higher than for a minimum ionizing particle). Streamer mode is not a strictly saturated regime, so that streamer charge is affected by the primary ionization loss. An enhanced production of multiple streamer is also possible for high ionization densities.

● RIASSUNTO

Si descrive un nuovo disegno di tubi a streamer in plastica, ottimizzati per le esigenze sperimentali di apparati sotterranei di grande area, dove si richiede l'identificazione di muoni con buona risoluzione angolare.

Подземное детектирование мюонов.

Резюме (*). — Предлагается новый проект пластических стримерных трубок, оптимально согласованный с экспериментальными требованиями подземных детекторов на большой площади, когда необходима идентификация мюонов с высокими угловым разрешением.

(*) *Переведено редакцией.*

G. BATTISTONI, *et al.*
Marzo-Aprile 1986
Il Nuovo Cimento
Serie 1, Vol. 9 C, pag. 653-660