

Φ and ω Meson Production in $\bar{n}p$ Annihilation and the OZI Rule

V.G. Ableev, M. Agnello, F. Balestra, G. Bendiscioli, A. Bertin, G.C. Bonazzola, E. Botta, T. Bressani, M. Bruschi, M.P. Bussa, L. Busso, D. Calvo, M. Capponi, B. Cereda, P. Cerello, C. Cicalò, M. Corradini, S. Costa, S. De Castro, F. D'Isep, A. Donzella, L. Fava, A. Feliciello, L. Ferrero, A. Filippi, V. Filippini, A. Fontana, T.D. Galli, R. Garfagnini, U. Gastaldi, B. Giacobbe, P. Giannotti, A. Grasso, C. Guaraldo, F. Iazzi, A. Lanaro, E. Lodi Rizzini, V. Lucherini, A. Maggiora, S. Marcello, U. Marconi, G.V. Margagliotti, A. Masoni, B. Minetti, P. Montagna, M. Morando, F. Nichitiu, M. Nupieri, D. Panzieri, G. Pauli, M. Piccinini, G. Puddu, E. Rossetto, A. Rotondi, A.M. Rozhdestvensky, A. Saino, P. Salvini, L. Santi, M.G. Sapozhnikov, N. Semprini Cesari, S. Serci, R. Spighi, P. Temnikov, S. Tessaro, F. Tosello, V.I. Tretyak, G.Usai, S. Vecchi, L. Venturelli, M. Villa, A. Vitale, A. Zenoni, A. Zoccoli, G. Zosi

Physics Letters B 334, 237-243, (1994)



ELSEVIER

11 August 1994

PHYSICS LETTERS B

Physics Letters B 334 (1994) 237–243

ϕ and ω meson production in $\bar{n}p$ annihilation and the OZI rule

OBELIX Collaboration

V.G. Ableevⁱ, M. Agnello^b, F. Balestra^g, G. Bendiscioli^d, A. Bertin^e, G.C. Bonazzola^g, E. Botta^g, T. Bressani^g, M. Bruschi^e, M.P. Bussa^g, L. Busso^g, D. Calvo^g, M. Capponi^e, B. Cereda^e, P. Cerello^g, C. Cicalò^a, M. Corradini^c, S. Costa^g, S. De Castro^e, F. D'Isep^g, A. Donzella^c, L. Fava^g, A. Feliciello^g, L. Ferrero^g, A. Filippi^g, V. Filippini^d, A. Fontana^d, T.D. Galli^e, R. Garfagnini^g, U. Gastaldi^f, B. Giacobbe^e, P. Gianotti^j, A. Grasso^g, C. Guaraldo^j, F. Iazzi^b, A. Lanaro^j, E. Lodi Rizzini^c, V. Lucherini^j, A. Maggiora^g, S. Marcello^g, U. Marconi^e, G.V. Margagliotti^k, A. Masoni^a, B. Minetti^b, P. Montagna^d, M. Morando^l, F. Nichitiu^j, M. Nupieri^j, D. Panzieri^g, G. Pauli^k, M. Piccinini^e, G. Puddu^a, E. Rossetto^g, A. Rotondi^d, A.M. Rozhdestvenskyⁱ, A. Saino^d, P. Salvini^d, L. Santiⁿ, M.G. Sapozhnikovⁱ, N. Semprini Cesari^e, S. Serci^a, R. Spighi^e, P. Temnikov^a, S. Tessaro^k, F. Tosello^g, V.I. Tretyak^d, G. Usai^a, S. Vecchi^e, L. Venturelli^c, M. Villa^e, A. Vitale^e, A. Zenoni^h, A. Zoccoli^e, G. Zosi^g

^a Dip. di Scienze Fisiche, Università di Cagliari and INFN, Sez. di Cagliari, I-09100 Cagliari, Italy

^b Politecnico di Torino and INFN, Sez. di Torino, I-10125 Torino, Italy

^c Dip. di Elettronica per l'Autom., Università di Brescia and INFN, Sez. di Torino, I-25060 Brescia, Italy

^d Dip. di Fisica Nucleare e Teorica, Università di Pavia and INFN, Sez. di Pavia, I-27100 Pavia, Italy

^e Dip. di Fisica, Università di Bologna and INFN, Sez. di Bologna, I-40100 Bologna, Italy

^f Laboratori Nazionali di Legnaro dell'INFN, I-35020 Legnaro, Italy

^g Istituto di Fisica, Università di Torino, and INFN, Sez. di Torino, I-10125 Torino, Italy

^h Dip. di Elettronica per l'Autom., Università di Brescia and INFN, Sez. di Pavia, I-27100 Pavia, Italy

ⁱ Joint Institute for Nuclear Research, Dubna, SU-101000 Moscow, Russia

^j Laboratori Nazionali di Frascati dell'INFN, I-00044 Frascati, Italy

^k Istituto di Fisica, Università di Trieste and INFN, Sez. di Trieste, I-34127 Trieste, Italy

^l Dip. di Fisica, Università di Padova and INFN, Sez. di Padova, I-35100 Padova, Italy

^m Dip. di Energetica, Università di Firenze and INFN, Sez. di Bologna, I-40100 Bologna, Italy

ⁿ Istituto di Fisica, Università di Udine and INFN, Sez. di Trieste, I-33100 Udine, Italy

Received 3 June 1994

Editor: L. Montanet

Abstract

The $\phi\pi^+/\omega\pi^+$ ratio from $\bar{n}p$ annihilations on a liquid hydrogen target, for \bar{n} momenta between 64 and 297 MeV/c, was measured using the OBELIX spectrometer at LEAR. The ratio $R(\phi\pi^+/\omega\pi^+) = \sigma(\bar{n}p \rightarrow \phi\pi^+)/\sigma(\bar{n}p \rightarrow \omega\pi^+)$ turned out $0.110 \pm 0.015_{\text{stat}} \pm 0.006_{\text{sys}}$. Implications of this result on the OZI rule are discussed.

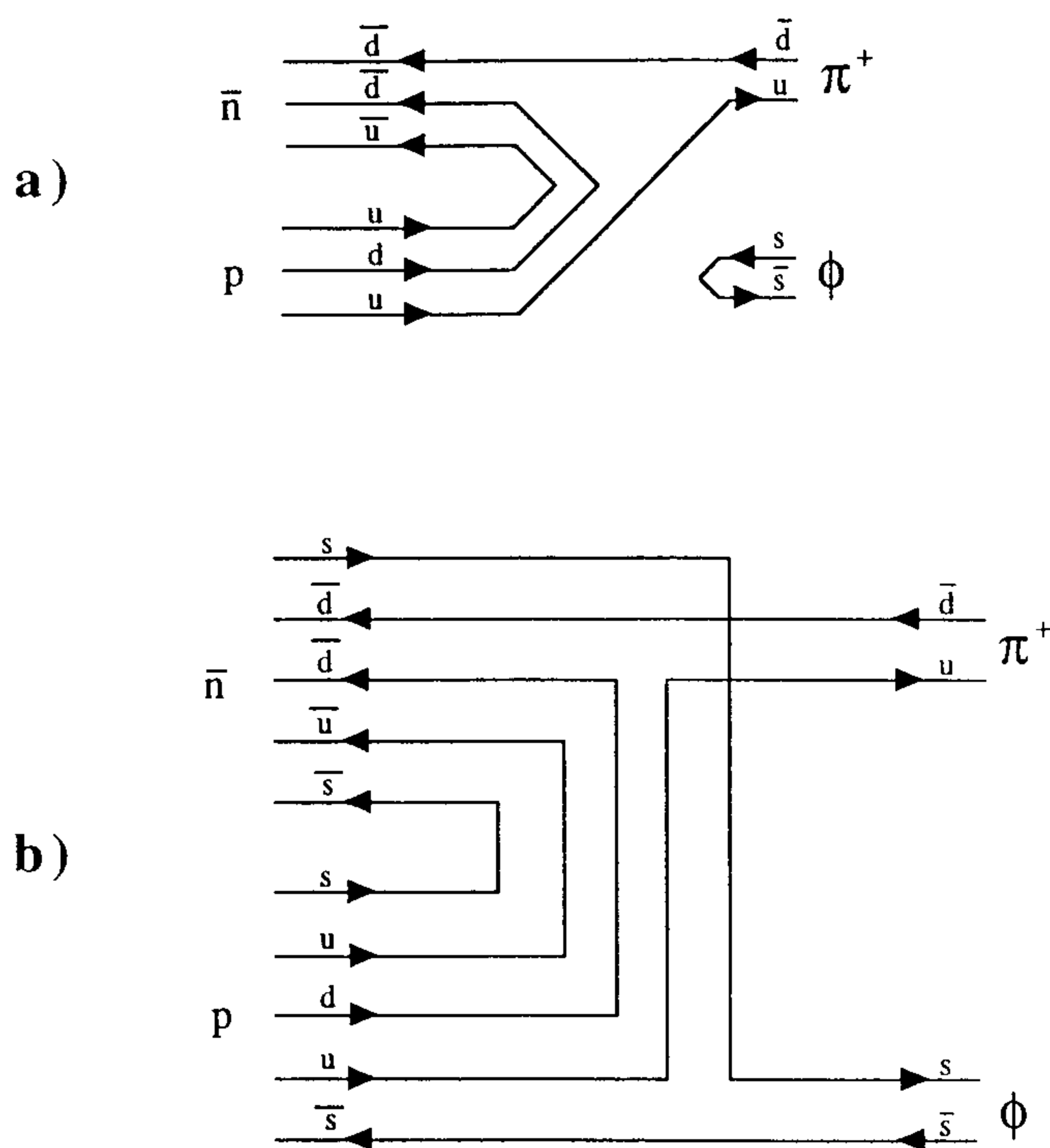

Fig. 1. Quark line diagrams for $\bar{n}p$ annihilation into $\phi\pi$ mesons: a) “hair pin” diagram, OZI forbidden; b) contribution from the strange sea.

The vector mesons are nearly ideal coherent admixtures of singlet and octet components of the nonet of SU(3). The quadratic Gell-Mann and Okubo mass formula suggests a physical mixing angle $\theta = 38.5^\circ$, not far from the ideal mixing angle $\theta_0 = 35.3^\circ$, this latter implying a pure $s\bar{s}$ composition for ϕ , and ω made only of u and d quarks. The Okubo-Zweig-Iizuka (OZI) rule [1] requires vanishing amplitudes for processes represented by disconnected quark diagrams. Thus, if the ϕ meson is a pure $s\bar{s}$ state, its coupling to non-strange hadrons through “hair pin” diagrams like that in Fig. 1a, should be suppressed by the OZI rule. The ϕ can be produced only via its $u\bar{u}$ and $d\bar{d}$ components.

For real mesons, i.e. in the case of nearly ideal mixing, the OZI rule requires that the ratio $R(\phi/\omega)$ between the production cross section of ϕ and ω be expressed by

$$R_{\text{OZI}}(\phi/\omega) \cong \text{tg}^2(\theta - \theta_0) \cong 0.003 \quad (1)$$

Substantial enhancement in ϕ production and hence significant deviation from OZI rule prediction characterize $\bar{p}p$ experimental results [2–12] in many channels and starting from different initial states [8]. The

recent data from Crystal Barrel and OBELIX at LEAR with $\phi(\omega)\pi$ and $\phi(\omega)\gamma$ in the final state [9–12] violate dramatically the theoretical ratio $R_{\text{OZI}}(\phi/\omega)$.

High ϕ production rates have been related to the production of gluonic states [13]. The particular role of $\phi\pi$ compared with $\omega\pi$ has also been assumed to be due to an intermediate cryptoexotic 4-quark state [14,15], a resonance in the $\phi\pi$ system, identified in the controversial C -meson(1480) [16,17]. An other possible mechanism for an increased ϕ rate has been suggested to be final state interaction of kaons [18–21], as rescattering of the K from K^* -decay on the directly produced K , thus forming a ϕ -meson via an OZI-allowed intermediate state.

The presence of strange quarks sea in protons could also justify the enhanced ϕ production [22,23]. Data on dimuon production in inelastic neutrino-proton interactions have shown [24] that the proton structure function contains a considerable contribution of strange quarks in contradiction with the naive quark model. Also other experiments seem to require a strange quark content of the proton: elastic neutrino-proton scattering [25], which show evidence for rather large axial vector matrix elements related to strange quark components in the proton wave function; the typical asymmetry parallel-antiparallel found in the inelastic cross section of longitudinally polarized muons scattered inelastically off polarized targets [26], discussed as “spin crisis of the proton” [27], requests that a substantial fraction of the proton spin should be carried by strange quarks and gluons [28]. If the strangeness is initially in the proton, the ϕ meson can be directly produced via the OZI-allowed connected diagram of Fig. 1b.

The exploration of the validity of the OZI rule has suggested to the OBELIX experiment at LEAR to start a systematic study of \bar{N} annihilations in the channels ϕX and ωX with $X = \pi^\pm$, using both \bar{p} and \bar{n} beams.

The result obtained by OBELIX for the $(\phi\pi/\omega\pi)$ production ratio in antiproton annihilation on deuterium target [11] is

$$R(\phi\pi/\omega\pi) = \frac{\sigma(\bar{p}n \rightarrow \phi\pi^-)}{\sigma(\bar{p}n \rightarrow \omega\pi^-)} = 0.133 \pm 0.026 \quad (2)$$

which indicates a significant deviation from the theoretical value given by Eq. (1).

In this letter we report a measurement on ϕ meson and ω meson production performed with the antineutron beam of the OBELIX facility on a liquid hydrogen target.

The following reactions have been investigated:

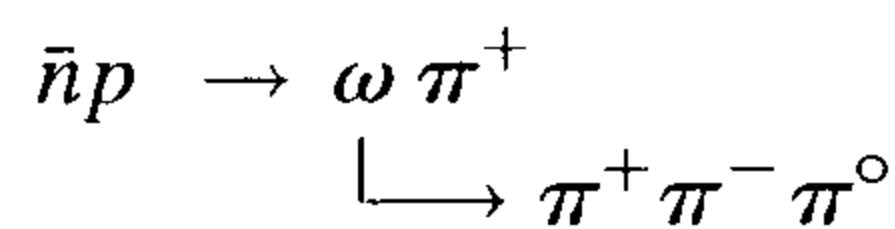
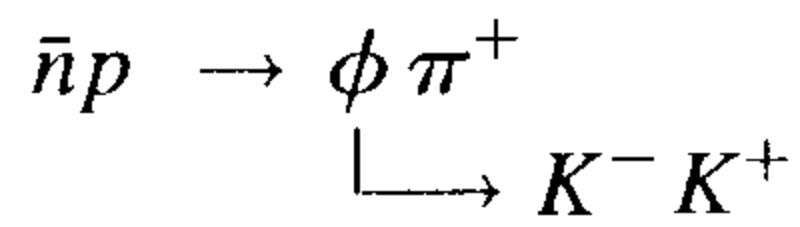

The antineutron momentum was in the band

$$64 \leq P_{\bar{n}} \leq 297 \text{ MeV}/c$$

The $(\phi\pi/\omega\pi)$ production ratio obtained by \bar{n} annihilation is much greater than the OZI prediction and in very good agreement with the value (2) obtained by the same experiment in \bar{p} annihilation on deuterium.

The data presented here were taken at LEAR with the OBELIX spectrometer able to detect charged and neutral (gamma) particles following the annihilation of antinucleons on nucleons or nuclei. The detector complex is described in detail in [29]. It consists of four sub-detectors arranged between and around the poles of the CERN Open Axial Field Magnet (OAFM): a Spiral Projection Chamber (SPC); a time-of-flight system (TOF); a Jet Drift Chamber (JDC); a High Angular Resolution Gamma Detector (HARGD). In the configuration used for the \bar{n} beam, the SPC has to be removed. Moreover, during the data taking referring to this analysis, the electromagnetic calorimeter was under calibration and, hence, its information was not used in the analysis.

The \bar{n} were produced via the charge exchange reaction $\bar{p}p \rightarrow \bar{n}n$ on liquid H₂ production target located in the upstream pole of the OAFM. The \bar{p} 's, while slowing down from 305 MeV/ c to 98 MeV/ c (the threshold for the charge exchange reaction), produced a \bar{n} beam with a $\sim 64 \div 297$ MeV/ c continuous momentum spectrum. The description of the experimental techniques related to the \bar{n} beam facility, as well as the trigger strategy, are described in Refs. [30,31]. In fact the present data are a subsample of the events collected during the runs described in Ref. [31].

A data sample of $\sim 2.3 \times 10^6$ events of $\bar{n}p$ annihilations was collected in two different runs (May 91 and June 92) using different first level triggers. The

data reduction of the original data sample proceeded through several steps. First of all, events with the vertex reconstructed in the target fiducial volume were selected. A second cut was based on the event topology: only events with three fully reconstructed tracks in JDC and belonging to the identified vertex, with the correct charge combination, were retained. In this way most of the background due to events with a wrong multiplicity of prongs and/or charge assignment was rejected. Furthermore, annihilations occurring outside the target region or on the mylar walls of the target were also rejected.

In order to isolate the exclusive final states, we imposed different criteria, according to the studied channel.

In the case of the reaction:

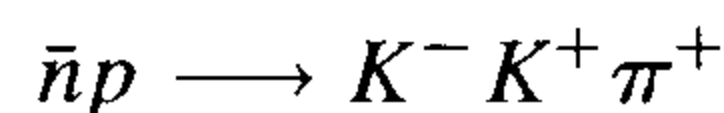

we required the identification of at least one kaon (by TOF), and imposed a 4C kinematical fit (CL 10%) to the hypothesis $K^- K^+ \pi^+$. We verified, as a check, that the squared missing mass spectrum was less than $0.01 \text{ GeV}^2/c^4$, which ensured no contamination from events with one π^0 missing.

The “monochromatic” π^+ (of $\approx 650 \text{ MeV}/c$) recoiling against the ϕ offered the opportunity to measure the momentum resolution of the detector, that turned out to have a σ less than 4.1%.

In the case of the reaction:

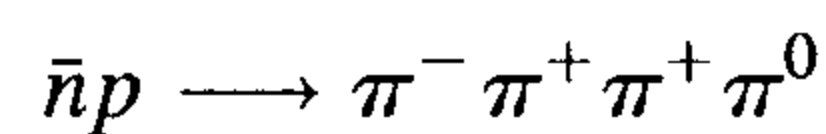

in which the π^0 it not detected (missing), we imposed a 1C kinematical fit (CL 10%) to the hypothesis $\pi^- \pi^+ \pi^+ \pi^0$ and a cut on missing mass, selecting only events with squared missing mass between $-0.06 \text{ GeV}^2/c^4$ and $0.08 \text{ GeV}^2/c^4$. In order to remove residual background, mainly represented by the competing reaction $\bar{n}p \rightarrow \pi^- \pi^+ \pi^+$, the remaining events were tested against this hypothesis. We retained only those events that satisfied the 4C kinematical fit with a CL less than 1%.

As a final result, after the application of all the cuts and selection criteria, the final data sample contained 1116 events for the $\bar{n}p \rightarrow K^- K^+ \pi^+$ channel, and 46854 events for the $\bar{n}p \rightarrow \pi^- \pi^+ \pi^+ \pi^0$ channel.

Fig. 2 shows the invariant mass spectrum for the $(K^- K^+)$ combinations.

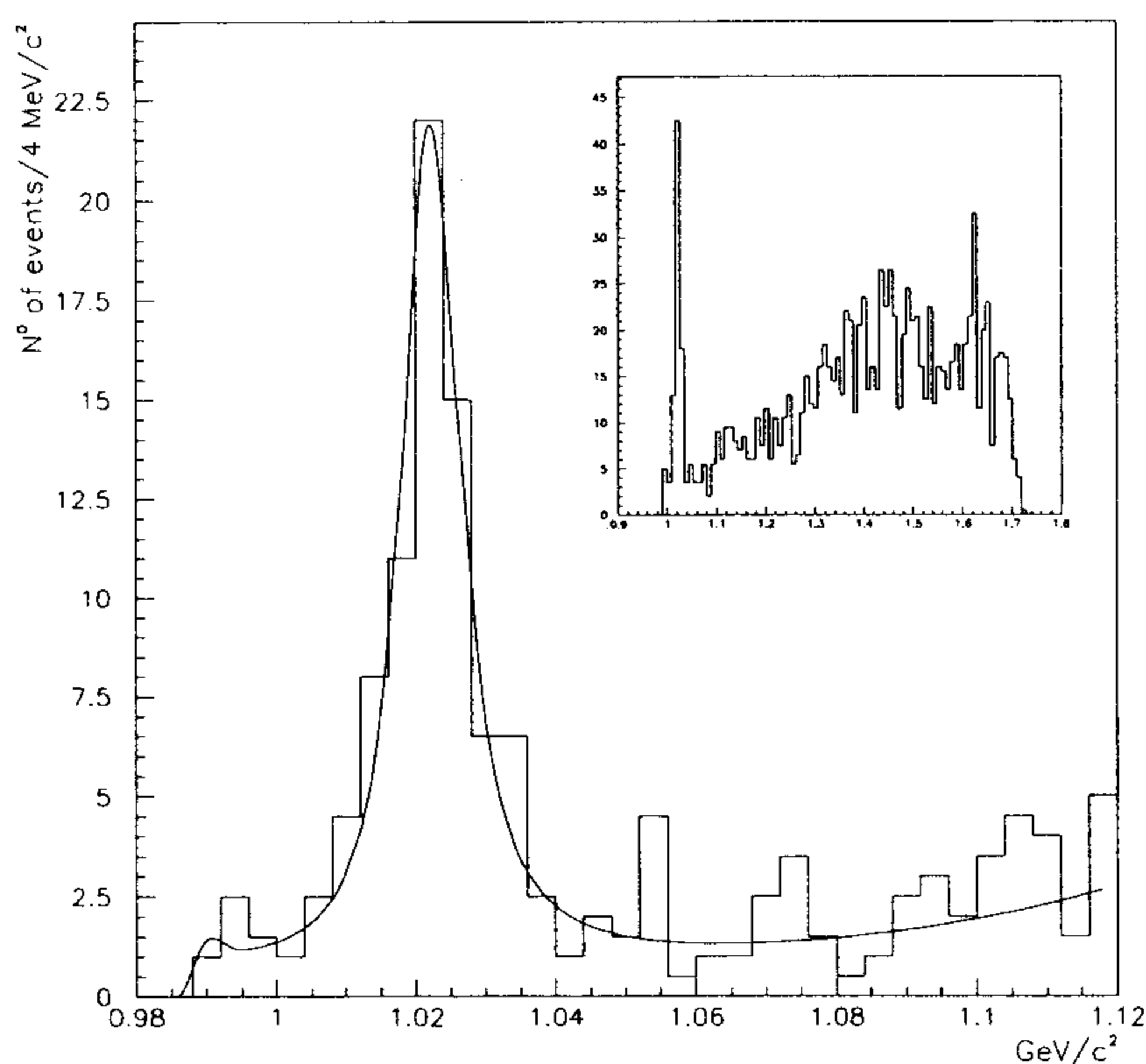

Fig. 2. K^-K^+ invariant mass for the $\bar{n}p \rightarrow K^-K^+\pi^+$ channel.

In the figure the energy region around the ϕ mass is plotted, together with a fit of the data. The fit has been done using the expression $f_{\text{fit}} = f_{\text{bg}}(m)[1 + \alpha\text{BW}(m)]$ where BW is a Breit-Wigner function convoluted with a Gaussian representing the resolution of the apparatus, and f_{bg} is the background expressed as $f_{\text{bg}} = \beta[(m - m_t)(m_f - m)]^\gamma$, where m_t represents the threshold mass for the K^+K^- system, m_f the kinematical maximum value accessible for the invariant mass $m(K^+K^-)$ and α, β, γ are parameters. In the inset of the figure, the whole spectrum is plotted, showing the narrow peak centered at the ϕ mass, well separated from the (relatively low) background. The obtained mass of ϕ was $m_\phi = 1022.3 \pm 0.9 \text{ MeV}/c^2$. The full width obtained from the fit ($\Gamma_\phi = 8.0 \pm 1.1 \text{ MeV}/c^2$) gave an experimental mass resolution $\sigma = 2.6 \pm 0.5 \text{ MeV}/c^2$. From the fit, the measured number of ϕ resulted: $N_\phi = 72 \pm 8$.

Fig. 3 shows the invariant mass spectrum for the $(\pi^-\pi^+\pi^0)$ combinations. In the region of ω meson, a clear peak emerges. In this channel, even with a background relatively high, the fit to the spectrum gave for the ω mass $m_\omega = 777.0 \pm 1.0 \text{ MeV}/c^2$, with a width $\Gamma_\omega = 34.7 \pm 4.4 \text{ MeV}/c^2$, implying an experimental mass resolution $\sigma = 14.4 \pm 1.9 \text{ MeV}/c^2$ for events with this topology.

Since in the $\pi^-\pi^+\pi^0$ channel the background is high, as it can be better seen in the inset of the figure, the method of the λ parameter [2] was used, in order

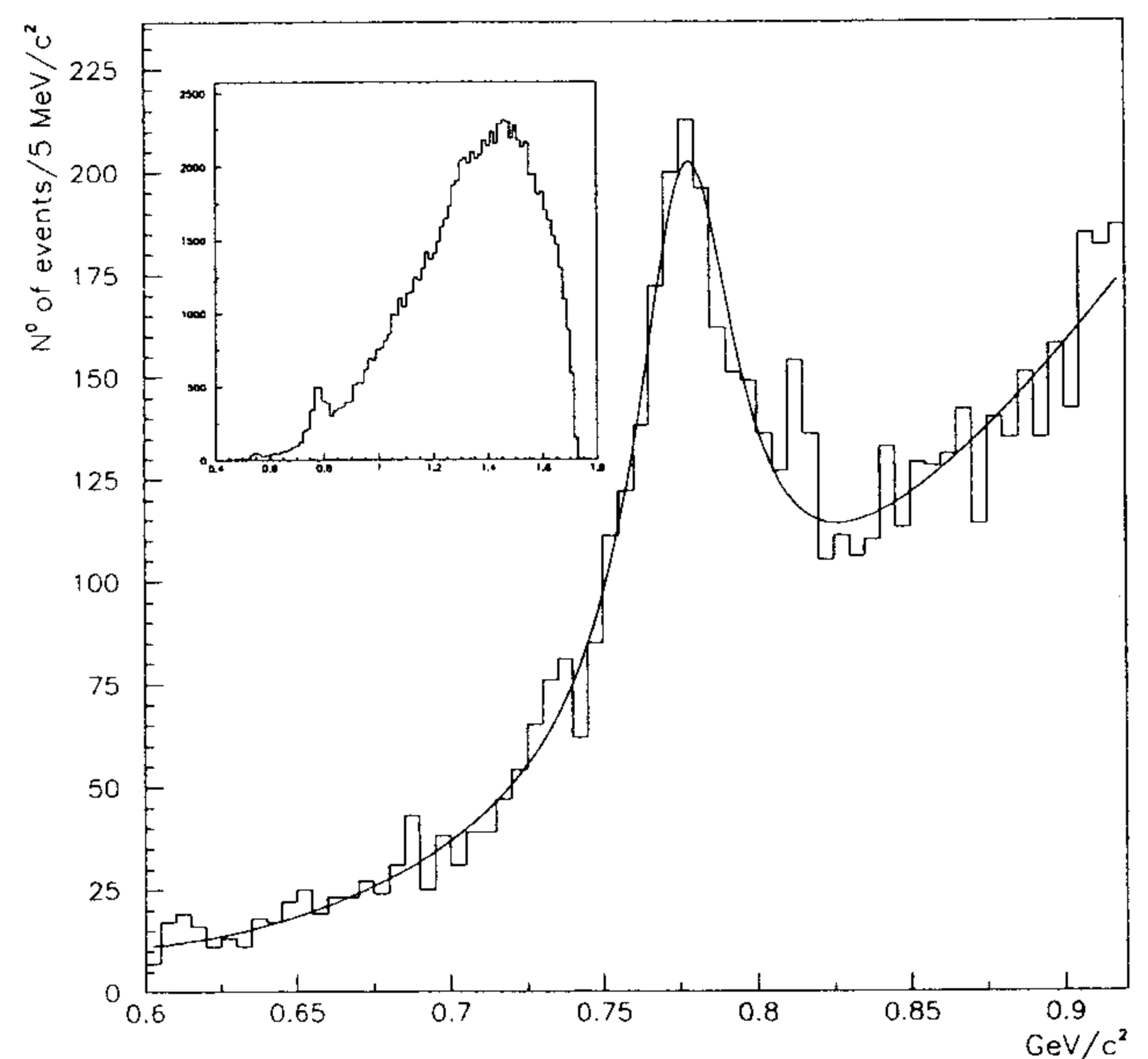

Fig. 3. $\pi^-\pi^+\pi^0$ invariant mass for the $\bar{n}p \rightarrow \pi^-\pi^+\pi^0$ channel.

to determine the number of ω in a reliable way. In fact, as shown in [2], the ω decay amplitude is proportional to the parameter:

$$\lambda = \frac{(q_1 \times q_2)^2}{\alpha(m^2 - \sum_i \mu_i^2)^2}$$

and hence, from the experimental distribution of the events as a function of λ , it is possible to perform a statistical discrimination between the ω signal and the background. Here m refers to the invariant mass of the $\pi^-\pi^+\pi^0$ system; μ_i , with i running from 1 to 3, indicates the mass of π^-, π^+, π^0 ; q_1 is the momentum of one of the three pions in the ω centre of mass system; q_2 the momentum of a second pion in the ω centre of mass system; $\alpha = 1/108$ is a normalization factor that ensures that λ runs from 0 to 1.

For a pure ω signal with no background, the events distribution versus λ is expected to be a straight line with positive slope crossing the origin. If only background is present, the corresponding λ distribution should be flat. In real cases, in which the ω signal lies above some background, the λ distribution will be the sum of the linear spectrum and a flat background. In Fig. 4 it is shown the distribution of events versus λ obtained for events belonging to the region of the $\pi^-\pi^+\pi^0$ invariant mass spectrum, centered on the ω peak and $\pm 40 \text{ MeV}/c^2$ wide. The distribution is nicely fitted by a straight line with positive slope due

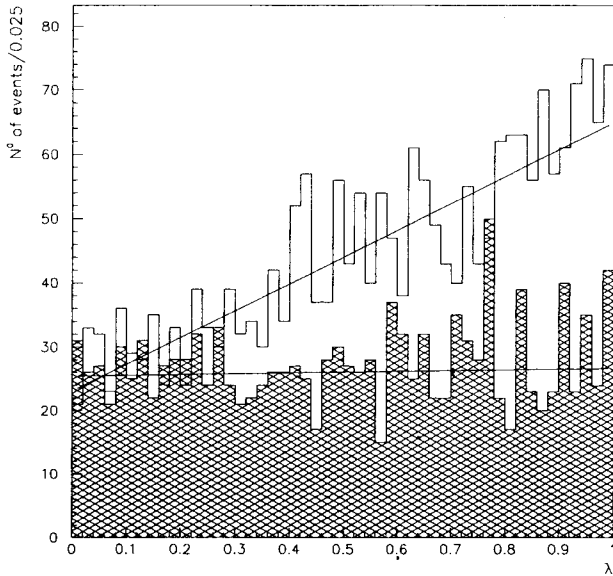

Fig. 4. Distribution in the $\pi^-\pi^+\pi^0$ invariant mass spectrum in the region of ω peak of events versus λ . The distribution is fitted by a straight line with positive slope due to the contribution of the ω . The hatched histogram (with its flat fit) is due to background events (see text).

to the contribution of the ω signal and whose intercept with the vertical axis gives the level of the background. As a check, the sum of the λ distributions obtained for events belonging to the two adjacent regions immediately before and after the selected one, and 40 MeV/c^2 wide each, is also shown in Fig. 4 (hatched histogram). This spectrum should correspond to background only and its linear fit is, in fact, flat. Doing successive fits with different cuts around the ω mass it was possible to obtain the constant number of ω which turned out to be: $N_\omega = 1046 \pm 81$.

Extensive Monte Carlo simulations have been performed in order to: 1) estimate contaminations of other channels under the ϕ and ω peaks; 2) calculate the overall efficiency for the selected channels, taking into account the full detector characteristics and the influence of the trigger and cuts.

The simulated channels that could introduce backgrounds in the obtained ϕ and ω signals were:

$$\bar{n}p \longrightarrow K^- K^+ \pi^+ \pi^0$$

$$\bar{n}p \longrightarrow K_s^0 K_{\text{miss}}^0 \pi^+$$

$$\bar{n}p \longrightarrow \pi^- \pi^+ \pi^+ \pi^0 \pi^0$$

Their contaminations were evaluated to be, with the

selected cuts, less than 0.2%.

The states 3S_1 and 1P_1 are the only initial states accessible to the $\phi\pi^+$ and $\omega\pi^+$ systems. In principle, it is possible, for the case of ϕ production, to select the initial state of annihilation. If one considers the angle θ between the ϕ momentum and the momentum of one of the kaons in the K^+K^- rest frame, the angular distribution is described by $\sin^2(\theta)$ for annihilation from the 3S_1 initial state, while the annihilation from the 1P_1 state would lead to a mostly uniform distribution.

In our case, the lack of statistics prevented us to obtain a clear answer on the percentage of initial states in the reaction under study. However, the ratio of the efficiencies obtained from Monte Carlo calculations in case of pure S- or P-wave turned out to be the same and equal to:

$$\frac{\epsilon^\omega(^3S_1)}{\epsilon^\phi(^3S_1)} \cong \frac{\epsilon^\omega(^1P_1)}{\epsilon^\phi(^1P_1)} = 0.887 \pm 0.025$$

The experimental ratio between the produced rates of ϕ and ω mesons in the annihilation process is given by the following expression:

$$\frac{\sigma(\bar{n}p \longrightarrow \phi\pi^+)}{\sigma(\bar{n}p \longrightarrow \omega\pi^+)} = \frac{N_\phi \epsilon^\omega D(\omega) I_{\bar{n}}^\omega}{N_\omega \epsilon^\phi D(\phi) I_{\bar{n}}^\phi}$$

where:

N_ϕ is the number of measured ϕ

N_ω is the number of measured ω

ϵ^ϕ is the detection efficiency for ϕ

ϵ^ω is the detection efficiency for ω

$D(\phi)$ is the decay mode percentage $\phi \rightarrow K^+K^-$

$D(\omega)$ is the decay mode percentage $\omega \rightarrow \pi^+\pi^-\pi^0$

$I_{\bar{n}}^{\phi,\omega}$ is the \bar{n} intensity

One has:

$$N_\phi = 72 \pm 8, \quad N_\omega = 1046 \pm 81$$

$$\epsilon^\omega/\epsilon^\phi = 0.887 \pm 0.025$$

$$D(\phi) = (49.1 \pm 0.8)\%, \quad D(\omega) = (88.8 \pm 0.6)\%$$

From which one gets:

$$\frac{\sigma(\bar{n}p \longrightarrow \phi\pi^+)}{\sigma(\bar{n}p \longrightarrow \omega\pi^+)} = 0.110 \pm 0.015_{\text{stat}}$$

where the reported error is statistical only.

As far as systematic errors on the ratio are concerned, since the data samples from which the channels have been analyzed have been collected in the same experimental conditions, systematic errors on

Table 1
Recent results on (ϕ/ω) ratio from Crystal Barrel and OBELIX

Channel	(ϕ/ω)	Ref.
$\bar{p}p \rightarrow \phi\gamma, \omega\gamma$	0.23 ± 0.09	[12]
$\bar{p}p \rightarrow \phi\pi^0, \omega\pi^0$	$0.14' \pm 0.04$	[10]
$\bar{p}p \rightarrow \phi\eta, \omega\eta$	0.006 ± 0.002	[9]
$\bar{n}p \rightarrow \phi\pi^+, \omega\pi^+$	0.110 ± 0.016	present work
$\bar{p}d \rightarrow \phi\pi^-, \omega\pi^-$	0.133 ± 0.026	[11]

detector performances or data taking fluctuations cancel each other and therefore do not affect the result. Systematic errors depending on χ^2 cuts for event selection or cuts on missing mass (in case of the ω meson) were carefully evaluated. A significant contribution came only from the systematic error associated to cuts on the missing mass, which turned out to be 5.7%.

The phase space for ϕ and ω production is different and therefore the measured ratio of cross sections may need to be corrected. Classically, the two body phase space is given by the decay momentum q . Vandermeulen [32], in the frame of the “nearest threshold dominance model” for the $\bar{p}p$ annihilation in two mesons, characterized by the dominance of annihilation channels with small momentum transfers from the $\bar{p}p$ system to the two mesons, has introduced a phenomenological factor, which scales the classical two body phase space, $f_V = q \exp[-A\sqrt{(s - s_{ab})}]$, where s is the invariant mass squared of the $\bar{p}p$ system and $s_{ab} = (m_a + m_b)^2$, with m_a and m_b masses of the two final state mesons. The correction factor on the ratio of the cross sections is therefore given by

$$F = \frac{q(\omega) \exp[-A\sqrt{(s - s_\omega)}]}{q(\phi) \exp[-A\sqrt{(s - s_\phi)}]} \quad (3)$$

where, $A = 1.2 (\text{GeV}/c^2)^{-1}$ [32], $s_\omega = (m_\pi + m_\omega)^2$, $s_\phi = (m_\pi + m_\phi)^2$. In our case, $q(\omega)/q(\phi) = 1.19$ and $F \cong 1$.

Finally, the corrected experimental $(\phi\pi/\omega\pi)$ production ratio turned out:

$$R_{\text{exp}}^c(\phi\pi/\omega\pi) = \frac{\sigma(\bar{n}p \rightarrow \phi\pi^+)}{\sigma(\bar{n}p \rightarrow \omega\pi^+)} \cdot F \\ = 0.110 \pm 0.015_{\text{stat}} \pm 0.006_{\text{syst}}$$

In Table 1 we compare the present result for the (ϕ/ω) ratio with the values recently obtained by the

Crystal Barrel and OBELIX Collaborations in various channels.

All values strongly deviate from the OZI rule prediction (1), with the exception of the $\phi(\omega)\eta$ channel, for which only a small difference has been measured.

In order to evaluate the magnitude of the OZI rule violation, following Okubo [33], let us define, for the case of ideally mixed vector mesons, in which ϕ is a pure $s\bar{s}$ state, the ratio Z of the matrix elements T for production of $s\bar{s}$ pair and non-strange the $q\bar{q}$ pair in $N\bar{N}$ annihilation:

$$Z = \frac{\sqrt{2}T(\bar{N}N \rightarrow M + \bar{s}s)}{T(\bar{N}N \rightarrow M + \bar{u}u) + T(\bar{N}N \rightarrow M + \bar{d}d)} \quad (4)$$

where M stands for non-strange mesons (pions). If the OZI rule is valid, the matrix element $T(\bar{N}N \rightarrow M + \bar{s}s)$, which can be described by the disconnected graph of Fig. 1a, should be suppressed, i.e. $Z = 0$. The magnitude of $|Z|$ then represents a measure of the violation of the OZI rule. In the real case, with ϕ and ω mesons mixed by the physical angle θ , one can analogously define the ratio β between the production amplitudes of ϕ and ω :

$$\beta = \frac{T(\bar{N}N \rightarrow M + \phi)}{T(\bar{N}N \rightarrow M + \omega)} \quad (5)$$

Therefore

$$|\beta|^2 = \frac{\sigma(\bar{N}N \rightarrow M + \phi)}{\sigma(\bar{N}N \rightarrow M + \omega)} \cdot F = R(\phi/\omega)F \\ = R^c(\phi/\omega) \quad (6)$$

where F is the correction factor which takes into account the different phase space for ϕ and ω production, previously defined (Eq. (3)).

By using the mixing formalism for the components of the SU(3) nonet and the definition (4), the measured ratio of production cross section $R(\phi/\omega)$ can be expressed in terms of the OZI parameter Z

$$|\beta|^2 = R(\phi/\omega) = \left| \frac{Z + \text{tg}(\theta - \theta_0)}{Z \text{tg}(\theta - \theta_0) - 1} \right|^2 \quad (7)$$

If the OZI rule is valid, $Z \ll 1$ and then

$$R_{\text{OZI}}(\phi/\omega) \cong \text{tg}^2(\theta - \theta_0) \cong 0.003$$

In the present case,

$$R_{\text{exp}}^c(\phi/\omega) = 0.110 \pm 0.016_{\text{stat+sys}} \quad (8)$$

Therefore we obtain

$$\frac{R_{\text{exp}}^c(\phi/\omega)}{R_{\text{OZI}}(\phi/\omega)} = 37 \pm 5 \quad (9)$$

which indicates a substantial deviation from the value predicted under the validity of the OZI rule.

To calculate the value of $|Z|$, since β is a complex quantity $\beta = |\beta| e^{i\gamma}$, where γ is an unknown phase factor, one gets from Eq. (7):

$$|Z|^2 = \frac{|\beta|^2 + 2 \operatorname{tg}(\theta - \theta_0) |\beta| \cos \gamma + \operatorname{tg}^2(\theta - \theta_0)}{\operatorname{tg}^2(\theta - \theta_0) |\beta|^2 - 2 \operatorname{tg}(\theta - \theta_0) |\beta| \cos \gamma + 1} \quad (10)$$

In our case, giving $|\beta|^2$ the measured value (8), we obtain the following boundaries for the parameter $|Z|$, which gives the magnitude of the OZI rule violation in $\bar{n}p \rightarrow \phi(\omega)\pi^+$ annihilation:

$$(0.272 \pm 0.023) < |Z| < (0.393 \pm 0.025) \quad (11)$$

In conclusion, a dramatic violation of the OZI rule, with a $(\phi\pi/\omega\pi)$ ratio a factor about 40 greater than the predicted theoretical value, was measured in antineutron proton annihilation. A corresponding value for the OZI parameter $|Z|$ between 0.27 and 0.39 was found. The same striking violation in the $\phi(\omega)\pi$ channels had been previously observed by ASTERIX and, more recently, by Crystal Barrel and OBELIX. Indeed OZI rule violation has been observed in many channels of $\bar{p}p$ annihilation and in $\bar{p}n$ annihilation. A strong dependence on the quantum numbers of the initial state has been observed. The $\phi\pi$ mode, in particular, strongly violates the OZI rule if the $\bar{p}p$ annihilation occurs from the spin-isospin triplet ${}^{33}S_1$ state.

Conventional approaches based on two-step processes for kaon formation with final state interaction seem at present not able to explain the violation.

The selectivity in favour of one specific channel might be justified by assuming a mixing of the initial state with a four-quark $s\bar{s}q\bar{q}$ state, a cryptoexotic, decaying preferentially $\phi\pi$, created in the intermediate stage. The experimental existence of such a state has however to be confirmed.

The intrinsic strangeness content of the nucleon remains as a reasonable assumption for explaining the observed OZI violations.

References

- [1] S. Okubo, Phys. Lett. 5 (1963) 165;
G. Zweig, CERN Report TH 412 (1964);
I. Iizuka, Prog. Theor. Phys. Suppl. 37-38 (1966) 21.
- [2] R. Bizzarri et al., Nucl. Phys. B 14 (1969) 169.
- [3] R.A. Donald et al., Phys. Lett. B 61 (1976) 210.
- [4] C.K. Chen et al., Nucl. Phys. B 130 (1977) 269.
- [5] A.M. Cooper et al., Nucl. Phys. B 146 (1978) 1.
- [6] M. Chiba et al., Phys. Rev. D 38 (1988) 2021.
- [7] C.B. Dover et al., Phys. Rev. Lett. 62 (1989) 2917.
- [8] J. Reifenroether et al., Phys. Lett. B 267 (1991) 299.
- [9] M.A. Faessler (Crystal Barrel Collab.), Hadron '93, Como 1993.
- [10] M.A. Faessler (Crystal Barrel Collab.), NAN '93, Moscow 1993.
- [11] M.G. Sapozhnikov (OBELIX Collab.), NAN '93, Moscow 1993.
- [12] U. Wiedner (Crystal Barrel Collab.), Few Body Problems, Williamsburg 1994.
- [13] A. Etkin et al., Phys. Lett. B 201 (1988) 568.
- [14] F.E. Close and H.J. Lipkin, Phys. Rev. Lett. 41 (1978) 1263;
Phys. Lett. B 196 (1987) 245.
- [15] C.B. Dover and P.M. Fishbane, Phys. Rev. Lett. 62 (1989) 2917.
- [16] S.I. Bityukov et al., Phys. Lett. B 88 (1987) 383.
- [17] L.G. Landsberg, Sov. J. Part. Nucl. 21 (1990) 446.
- [18] Y. Lu et al., Z. Phys. A 345 (1993) 207.
- [19] D. Buzatu et al., JINR preprint E4-93-376 Dubna (1993).
- [20] M.P. Lodur, Y. Lu and B.-S. Zou, Z. Phys. A 347 (1994) 281.
- [21] K. Konigsmann, CERN preprint, PPE/93-182, Geneva 1993.
- [22] J. Ellis, E. Gabathuler and M. Karliner, Phys. Lett. B 217 (1989) 173.
- [23] J. Ellis and M. Karliner, Phys. Lett. B 313 (1993) 407.
- [24] H. Abramowicz et al., Z. Phys. C 15 (1982) 19.
- [25] L.A. Ahrens et al., Phys. Rev. D 34 (1986) 175; D 35 (1987) 785.
- [26] J. Ashman et al., Phys. Lett. B 206 (1988) 364; Nucl. Phys. A 328 (1989) 1.
- [27] S. Brodsky, J. Ellis and M. Karliner, Phys. Lett. B 206 (1988) 309.
- [28] J. Ellis, R. Flores and S. Ritz, Phys. Lett. B 198 (1987) 393.
- [29] A. Adamo et al., Sov. J. Nucl. Phys. 55 (1992) 1732.
- [30] F. Iazzi, Intense Hadron Facilities and Antiproton Physics, Eds. T. Bressani, F. Iazzi and G. Pauli (SIF, Bologna 1990) 171.
- [31] A. Adamo et al., Phys. Lett. B 287 (1992) 368.
- [32] J. Vandermeulen, Z. Phys. C 37 (1988) 563.
- [33] S. Okubo, Phys. Rev. D 16 (1977) 2336.